

# the home library

LIGHTING & INTERIORS



Luxury Bespoke Furniture

SPRING SUMMER 2021

## Handmade in England

Sofas and Chairs are at the heart of a room so we have teamed up with carefully chosen UK manufacturing partners to bring you an exceptional range of beautiful sofas and chairs. Your choice of sofa or chair will be made in our partners UK workrooms by skilled craftsmen drawing on decades of experience and heritage using the finest materials. From the construction of the robust wood frames to the smallest detail of hand finishing the upholstery, our expert teams work with passion and care to produce furniture of the greatest comfort and style to your unique specification.



## Quality Guarantee

Our manufacturing partners select each material to ensure the highest quality and rigorously test each element to ensure long lasting durability and comfort, from frames to springs to upholstery. Our padding comprises superior grade foam, felts, feathers and dacron fibres to provide a sumptuous plumpness. Not forgetting the legs – they may be small but they are important. All our furniture legs are constructed from hardwood and expertly crafted in a range of signature stained finishes.

Our sofas come with a 5 year guarantee for your peace of mind. This covers manufacturing defects for the frame and upholstery. We recommend taking out a care policy that will insure your sofa from accidental damage for up to 5 years. We can take you through the details of this policy and put this in place for you.



## Bespoke Options

Your sofa or chair can be made in your fabric choice. We have an extensive range of fabric collections to choose from including luxurious velvets and linens, to hard wearing timeless ticking stripes. We are here to offer help and advice in selecting the perfect fabric for your furniture and have a wealth of experience to share to give you the peace of mind that the fabric you choose will give you the finish and durability you expect.



## Delivery

Our delivery partner will ensure that your order is delivered safely and placed into your room with care and consideration, taking all packaging away before they leave. We will need a little information from you to make sure things go smoothly on the day – our handy delivery guide on page 22 explains this in more detail.

## Our Service

We are delighted you are considering us to supply your new furniture. Our aim is to make choosing your interior style as easy as possible by bringing together, in one place, collections of inspirational furniture, fabrics, lighting and accessories. We love browsing through different styles, textures and colours and talking about our collections and sharing experience. Come and have a chat and explore the possibilities. If you have something in mind or are looking for inspiration or advice we can guide you through the options and choices to find your perfect style. Pop in, we would love to meet you.



Get to know your sofa...



# ...inside and out

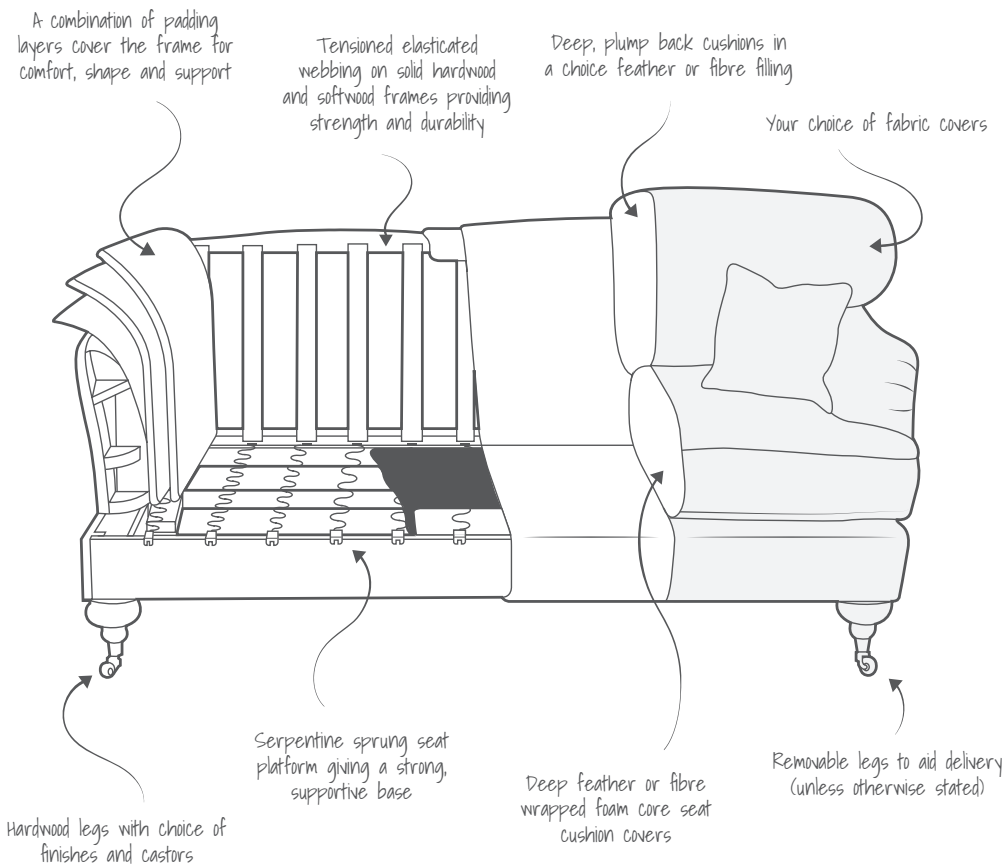

Our materials are compliant to the relevant fire regulations

Our wood is sourced from either FSC accredited sources or sustainably farmed timber

5 year manufacturing guarantee on the frames and upholstery

Optional 5 year guarantee available for accidental damage

# Padstow

Classic English styling combined with an iconic Howard style pleated arm to create a smart yet relaxed touch of luxury

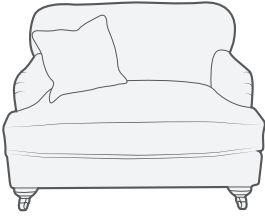

Armchair

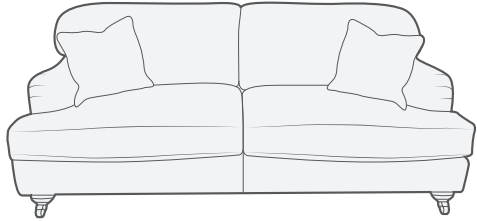

2 Seat Sofa

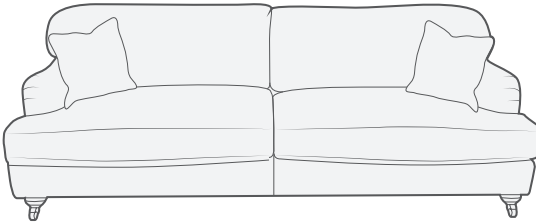

3 Seat Sofa

| Model       | Total Width | Total Depth | Total Height | Seat Height | Internal Width | Internal Depth | Scatter Cushions |
|-------------|-------------|-------------|--------------|-------------|----------------|----------------|------------------|
| Armchair    | 102cm       | 98cm        | 83cm         | 48cm        | 66cm           | 58cm           | 1 x 43cm         |
| 2 Seat Sofa | 185cm       | 98cm        | 83cm         | 48cm        | 149cm          | 58cm           | 2 x 43cm         |
| 3 Seat Sofa | 215cm       | 98cm        | 83cm         | 48cm        | 179cm          | 58cm           | 2 x 43cm         |

**Back Cushions** Fibre back cushions

**Seat Cushions** High quality foam seats with deep fibre wrap (as standard) or with a deep feather wrap

**Scatter Cushions** Feather (fibre option available)

**Feet Finish** Oak finished in black or antique oak with brass, brushed nickel, polished or black chrome castors



Traditionally inspired with a curved fixed back, generously plump deep seats and elegant low curved arms for timeless elegance

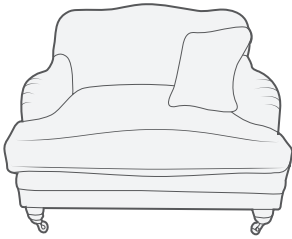

Armchair

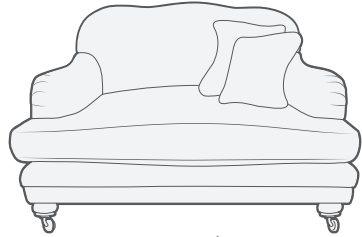

Loveseat

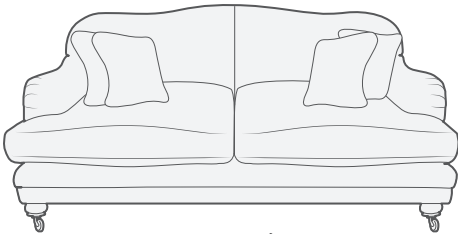

2 Seat Sofa

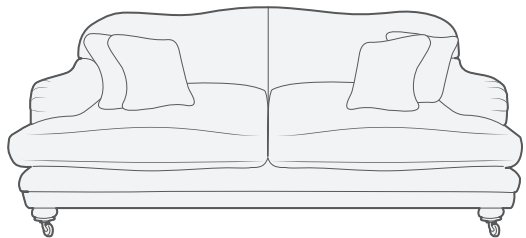

2 Seat Sofa Grande

| Model          | Total Width | Total Depth | Total Height | Seat Height | Internal Width | Internal Depth | Scatter Cushions  |
|----------------|-------------|-------------|--------------|-------------|----------------|----------------|-------------------|
| Armchair       | 115cm       | 102cm       | 92cm         | 48cm        | 75cm           | 63cm           | 1 x 43cm          |
| Loveseat       | 140cm       | 102cm       | 92cm         | 48cm        | 100cm          | 63cm           | 2 x 43cm          |
| 2 Seat Sofa    | 180cm       | 102cm       | 92cm         | 48cm        | 140cm          | 63cm           | 2 x 43 + 2 x 50cm |
| 2 Seat Grande  | 205cm       | 102cm       | 92cm         | 48cm        | 165cm          | 63cm           | 2 x 43 + 2 x 50cm |
| 3 Seat Grande* | 230cm       | 102cm       | 92cm         | 48cm        | 190cm          | 63cm           | 2 x 43 + 2 x 50cm |

\* Not shown

**Back Cushions** Fixed sprung back

**Seat Cushions** High quality foam seats with deep feather wrap (as standard) or with a deep fibre wrap

**Scatter Cushions** Feather (fibre option available)

**Feet Finish** Oak finished in black or antique oak with brass, brushed nickel, polished or black chrome castors

# Campden

A touch of Art Deco styling with sweeping curved arms gives a soft line for either a modern or period room



Footstool

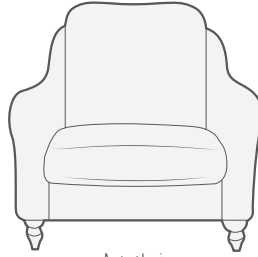

Armchair

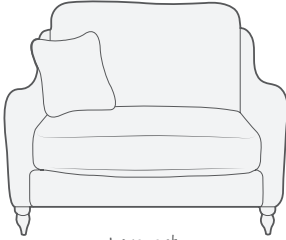

Loveseat

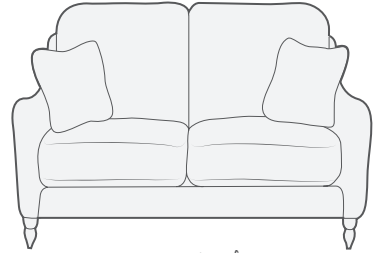

2.5 Seat Sofa

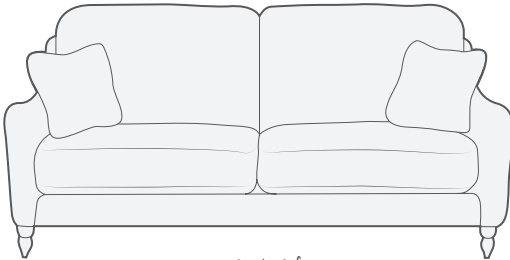

3.5 Seat Sofa

| Model         | Total Width | Total Depth | Total Height | Seat Height | Internal Width | Internal Depth | Scatter Cushions |
|---------------|-------------|-------------|--------------|-------------|----------------|----------------|------------------|
| Footstool     | 99cm        | 69cm        | 34cm         | –           | –              | –              | –                |
| Armchair      | 80cm        | 107cm       | 103cm        | 47cm        | 56cm           | 60cm           | –                |
| Loveseat      | 114cm       | 107cm       | 103cm        | 47cm        | 90cm           | 60cm           | 1 x 40cm         |
| 2.5 Seat Sofa | 144cm       | 107cm       | 103cm        | 47cm        | 120cm          | 60cm           | 2 x 40cm         |
| 3 Seat Sofa * | 176cm       | 107cm       | 103cm        | 47cm        | 152cm          | 60cm           | 2 x 40cm         |
| 3.5 Seat Sofa | 204cm       | 107cm       | 103cm        | 47cm        | 180cm          | 60cm           | 2 x 40cm         |
| 4 Seat Sofa * | 234cm       | 107cm       | 103cm        | 47cm        | 210cm          | 60cm           | 2 x 40cm         |

\* Not shown

|                         |   |
|-------------------------|---|
| <b>Back Cushions</b>    | Duck feather back cushions                                      |
| <b>Seat Cushions</b>    | High quality foam seats with a deep fibre wrap                  |
| <b>Scatter Cushions</b> | Feather (fibre option available)                                |
| <b>Feet Finish</b>      | Beech finished in natural, light oak, ebony, mahogany and black |

If access is restricted, arms can be detached for delivery and refitted once in place. This service must be booked prior to delivery.



A modern take on a traditional scrolled arm style with relaxed comfort. A customer favourite, at home in a classic or contemporary space

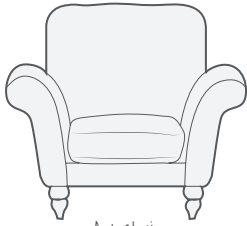

Armchair

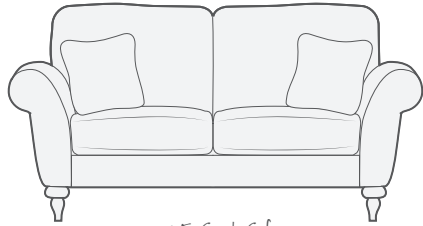

2.5 Seat Sofa

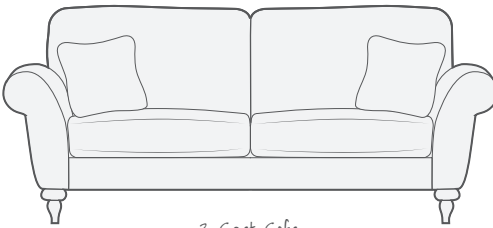

3 Seat Sofa

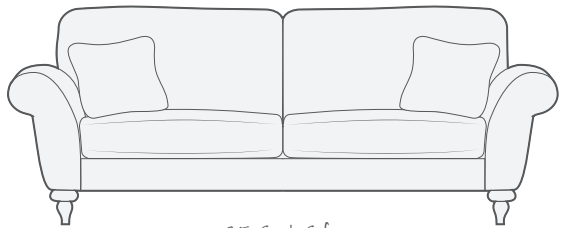

3.5 Seat Sofa

| Model         | Total Width | Total Depth | Total Height | Seat Height | Internal Width | Internal Depth | Scatter Cushions |
|---------------|-------------|-------------|--------------|-------------|----------------|----------------|------------------|
| Armchair      | 94cm        | 99cm        | 87cm         | 48cm        | 56cm           | 58cm           | –                |
| 2.5 Seat Sofa | 158cm       | 99cm        | 87cm         | 48cm        | 120cm          | 58cm           | 2 x 40cm         |
| 3 Seat Sofa   | 190cm       | 99cm        | 87cm         | 48cm        | 150cm          | 58cm           | 2 x 40cm         |
| 3.5 Seat Sofa | 218cm       | 99cm        | 87cm         | 48cm        | 180cm          | 58cm           | 2 x 40cm         |

- Back Cushions** Duck feather back cushions
- Seat Cushions** High quality foam seats with a deep fibre wrap
- Scatter Cushions** Feather (fibre option available)
- Feet Finish** Beech finished in natural, light oak, ebony, mahogany and black

If access is restricted, arms can be detached for delivery and refitted once in place. This service must be booked prior to delivery.

# Prestbury

This beautiful high back style with sweeping curved arms gives clean lines with great comfort



Footstool

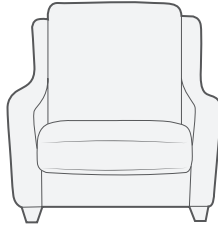

Armchair

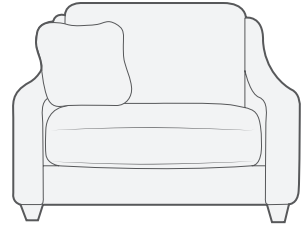

Loveseat

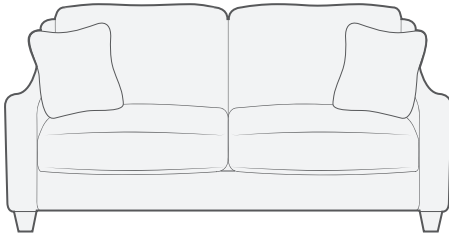

2.5 Seat Sofa

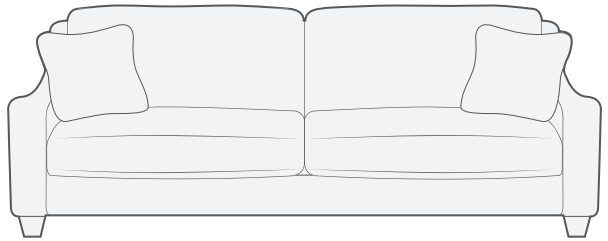

3.5 Seat Sofa

| Model         | Total Width | Total Depth | Total Height | Seat Height | Internal Width | Internal Depth | Scatter Cushions |
|---------------|-------------|-------------|--------------|-------------|----------------|----------------|------------------|
| Footstool     | 90cm        | 62cm        | 35cm         | –           | –              | –              | –                |
| Armchair      | 85cm        | 101cm       | 93cm         | 46cm        | 56cm           | 60cm           | –                |
| Loveseat      | 119cm       | 101cm       | 93cm         | 46cm        | 90cm           | 60cm           | 1 x 40cm         |
| 2 Seat Sofa * | 149cm       | 101cm       | 93cm         | 46cm        | 120cm          | 60cm           | 2 x 40cm         |
| 2.5 Seat Sofa | 181cm       | 101cm       | 93cm         | 46cm        | 152cm          | 60cm           | 2 x 40cm         |
| 3 Seat Sofa * | 209cm       | 101cm       | 93cm         | 46cm        | 180cm          | 60cm           | 2 x 40cm         |
| 3.5 Seat Sofa | 239cm       | 101cm       | 93cm         | 46cm        | 210cm          | 60cm           | 2 x 40cm         |

\* Not shown

|                         |   |
|-------------------------|---|
| <b>Back Cushions</b>    | Duck feather back cushions                                      |
| <b>Seat Cushions</b>    | High quality foam seats with a deep fibre wrap                  |
| <b>Scatter Cushions</b> | Feather (fibre option available)                                |
| <b>Feet Finish</b>      | Beech finished in natural, light oak, ebony, mahogany and black |

If access is restricted, arms can be detached for delivery and refitted once in place. This service must be booked prior to delivery.

# Prestbury Curved

The curved version of our Prestbury range looks stunning from every angle

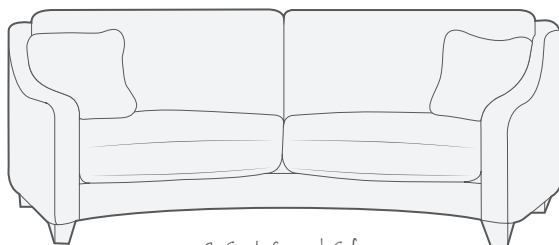

3 Seat Curved Sofa

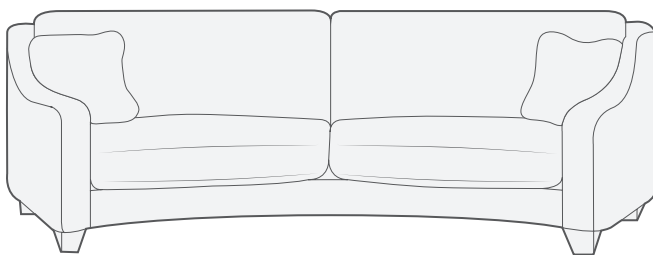

4 Seat Curved Sofa

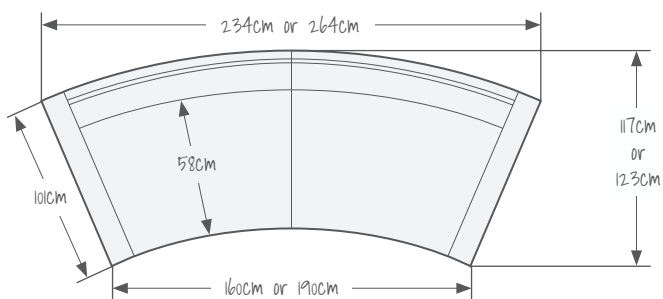

Plan View of Curved Sofa

| Model         | Total Width | Total Depth | Total Height | Seat Height | Scatter Cushions |
|---------------|-------------|-------------|--------------|-------------|------------------|
| 3 Seat Curved | 234cm       | 117cm       | 93cm         | 46cm        | 2 x 40cm         |
| 4 Seat Curved | 264cm       | 123cm       | 93cm         | 46cm        | 2 x 40cm         |

- Back Cushions** Duck feather back cushions
- Seat Cushions** High quality foam seats with a deep fibre wrap
- Scatter Cushions** Feather (fibre option available)
- Feet Finish** Beech finished in natural, light oak, ebony, mahogany and black

If access is restricted, arms can be detached for delivery and refitted once in place. This service must be booked prior to delivery.

# Woodstock

Traditional Chesterfield styling with the refinement of a plain back gives a contemporary twist to this timeless shape.

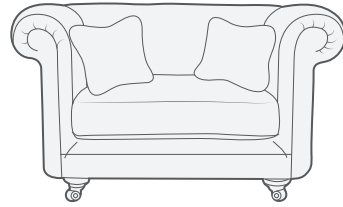

Loveseat

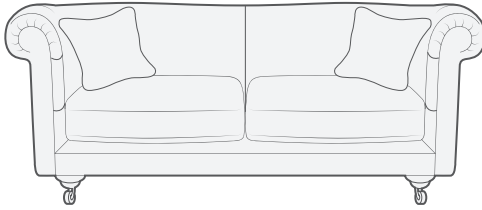

2 Seat Sofa

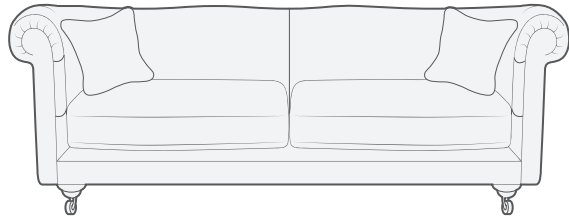

3 Seat Sofa

| Model       | Total Width | Total Depth | Total Height | Seat Height | Internal Width | Internal Depth | Scatter Cushions |
|-------------|-------------|-------------|--------------|-------------|----------------|----------------|------------------|
| Loveseat    | 135cm       | 100cm       | 76cm         | 48cm        | 75cm           | 64cm           | 2 x 43cm         |
| 2 Seat Sofa | 190cm       | 100cm       | 76cm         | 48cm        | 130cm          | 64cm           | 2 x 50cm         |
| 3 Seat Sofa | 225cm       | 100cm       | 76cm         | 48cm        | 165cm          | 64cm           | 2 x 50cm         |

**Back Cushions** Fixed sprung back

**Seat Cushions** High quality foam seats with a deep feather wrap

**Scatter Cushions** Feather (fibre option available)

**Feet Finish** Oak finished in black or antique oak with brass, brushed nickel, polished or black chrome castors

Vintage deep buttoned detailing twinned with modern comfort makes this an iconic style that will never date

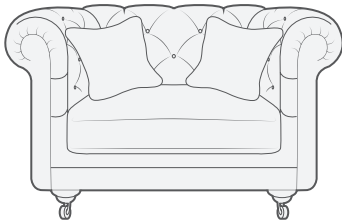

LOVESEAT

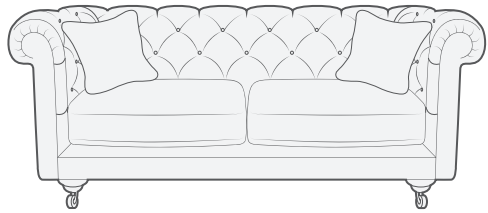

2 Seat Sofa

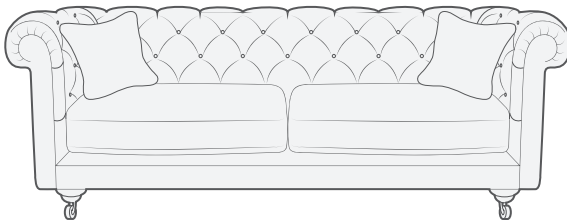

3 Seat Sofa

| Model       | Total Width | Total Depth | Total Height | Seat Height | Internal Width | Internal Depth | Scatter Cushions |
|-------------|-------------|-------------|--------------|-------------|----------------|----------------|------------------|
| Loveseat    | 135cm       | 100cm       | 76cm         | 48cm        | 75cm           | 64cm           | 2 x 43cm         |
| 2 Seat Sofa | 190cm       | 100cm       | 76cm         | 48cm        | 130cm          | 64cm           | 2 x 50cm         |
| 3 Seat Sofa | 225cm       | 100cm       | 76cm         | 48cm        | 165cm          | 64cm           | 2 x 50cm         |

- Back Cushions** Fixed sprung back with deep buttoning
- Seat Cushions** High quality foam seats with a deep feather wrap
- Scatter Cushions** Feather (fibre option available)
- Feet Finish** Oak finished in black or antique oak with brass, brushed nickel, polished or black chrome castors

# Tunbridge

Modern, clean lines and neat styling are a feature of this comfortable and versatile range

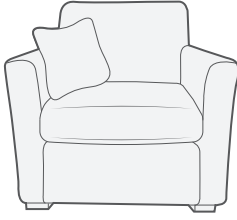

Armchair

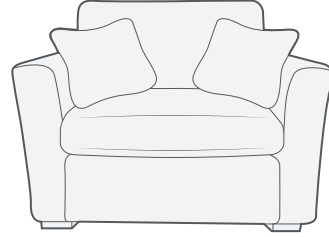

Loveseat

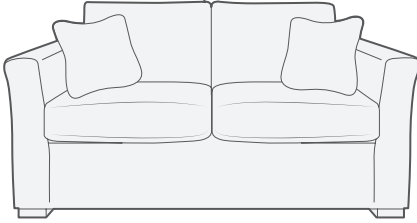

2 Seat Sofa

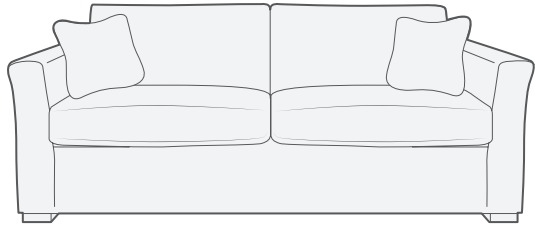

3 Seat Sofa

| Model       | Total Width | Total Depth | Total Height | Seat Height | Internal Width | Internal Depth | Scatter Cushions |
|-------------|-------------|-------------|--------------|-------------|----------------|----------------|------------------|
| Armchair    | 92cm        | 99cm        | 90cm         | 46cm        | 52cm           | 62cm           | 1 x 40cm         |
| Loveseat    | 128cm       | 99cm        | 90cm         | 46cm        | 88cm           | 62cm           | 2 x 40cm         |
| 2 Seat Sofa | 178cm       | 99cm        | 90cm         | 46cm        | 138cm          | 62cm           | 2 x 40cm         |
| 3 Seat Sofa | 217cm       | 99cm        | 90cm         | 46cm        | 177cm          | 62cm           | 2 x 40cm         |

|                  |  |
|------------------|--|
| Back Cushions    | Duck feather/fibre mix                           |
| Seat Cushions    | High quality foam seats with a deep feather wrap |
| Scatter Cushions | Feather (fibre option available)                 |
| Feet Finish      | Solid wood feet in natural or wenge finish       |

# Tunbridge Sofa Bed

This contemporary box shaped sofa transforms into a stylish guest bed. See our flexible modular configurations on the next page

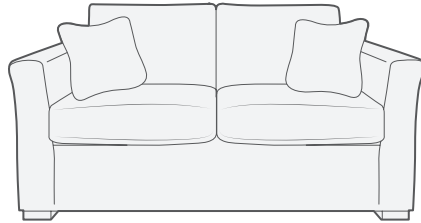

2 Seat Sofa Bed

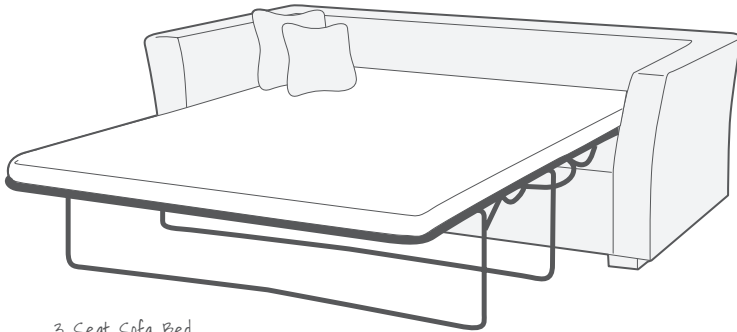

3 Seat Sofa Bed

| Model           | Total Width | Total Depth | Total Height | Seat Height | Internal Width | Internal Depth | Extended Length | Mattress Width | Mattress Length | Scatter Cushions |
|-----------------|-------------|-------------|--------------|-------------|----------------|----------------|-----------------|----------------|-----------------|------------------|
| 2 Seat Sofa Bed | 178cm       | 99cm        | 90cm         | 48cm        | 138cm          | 62cm           | 225cm           | 133cm          | 183cm           | 2 x 50cm         |
| 3 Seat Sofa Bed | 210cm       | 99cm        | 90cm         | 48cm        | 170cm          | 62cm           | 225cm           | 143cm          | 183cm           | 2 x 50cm         |

|                         |  |
|-------------------------|--|
| <b>Back Cushions</b>    | Duck feather/fibre mix   |
| <b>Seat Cushions</b>    | High quality foam seats with a deep feather wrap               |
| <b>Scatter Cushions</b> | Feather (fibre option available)                               |
| <b>Feet Finish</b>      | Solid wood feet in natural or wenge finish                     |
| <b>Mechanism</b>        | Contract quality frame with wood slat and webbing deck support |
| <b>Mattress</b>         | 10" deep sprung mattress suitable for daily use                |

The sofa bed will feel firmer than our standard sofas due to the integral bed mechanism



# Tunbridge Modular

Personalise our Tunbridge modular system to create the ideal seating arrangement for your living space.

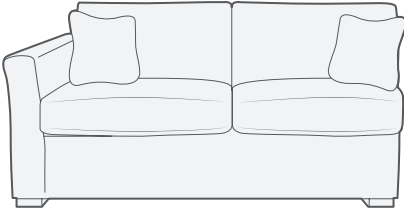

L/H or R/H Arm 2 Seat Sofa (various sizes – see below)

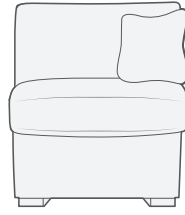

Armless Single Sofa (various sizes – see below)

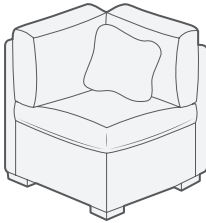

Square Corner Unit

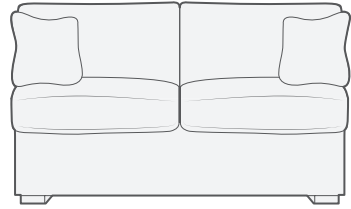

Armless 2 Seat Sofa (various sizes – see below)

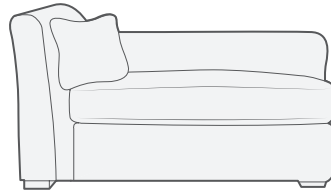
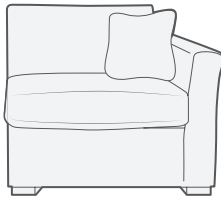

L/H or R/H Chaise (front and side view)

| Model                 | Total Width | Total Depth | Total Height | Seat Height |
|-----------------------|-------------|-------------|--------------|-------------|
| 2 Seat Sofa (L/R arm) | 158cm       | 99cm        | 90cm         | 48cm        |
| 3 Seat Sofa (L/R arm) | 198cm       | 99cm        | 90cm         | 48cm        |
| Small Single (no arm) | 70cm        | 99cm        | 90cm         | 48cm        |
| Large Single (no arm) | 90cm        | 99cm        | 90cm         | 48cm        |
| 2 Seat Sofa (no arm)  | 140cm       | 99cm        | 90cm         | 48cm        |
| 3 Seat Sofa (no arm)  | 180cm       | 99cm        | 90cm         | 48cm        |
| Square Corner Unit    | 99cm        | 99cm        | 90cm         | 48cm        |
| Chaise (L/R arm)      | 179cm       | 99cm        | 90cm         | 48cm        |

## Top tips

- Always unclip the pieces before you try to move the sofa.
  - Don't force the clips, they should fit together easily.
- Never drag the sofa - always lift it to protect your floor and the sofa brackets.
  - Make sure the sofa is properly connected before you sit on it.
    - Avoid sitting on the arms.

2 Seat Sofa  
(L/H arm)

Corner unit

Large Single  
(no arm)

3 Seat Sofa  
(R/H arm)

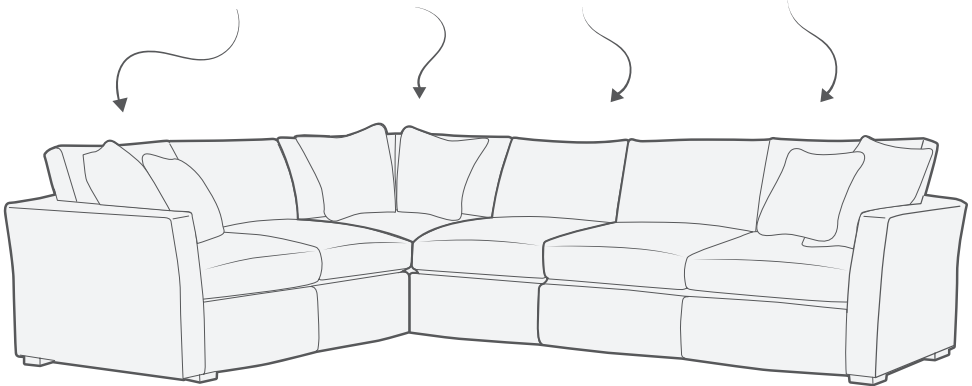

4 Piece Combination as shown - L/H Arm Sofa (various sizes) + Corner Unit + Large Single + R/H Arm Sofa (various sizes)

Chaise (L/H arm)

2 Seat Sofa (R/H arm)

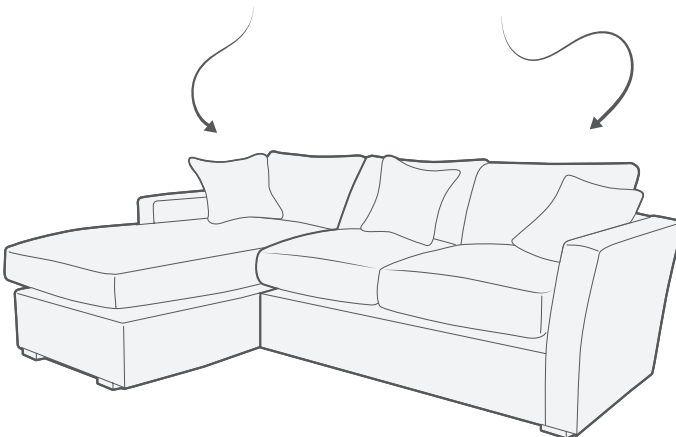

2 Piece combination as shown - L/H Chaise + R/H Arm Sofa (various sizes)

# Henley

Relaxed styling teamed with great comfort and flexibility makes this a popular family choice

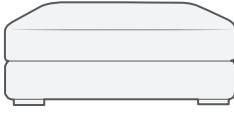

Footstool

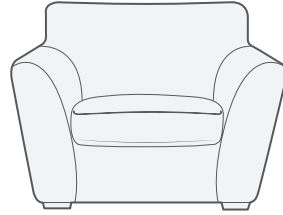

Armchair

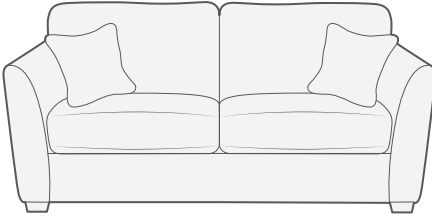

2.5 Seat Sofa

| Model          | Total Width | Total Depth | Total Height | Seat Height | Internal Width | Internal Depth | Scatter Cushions |
|----------------|-------------|-------------|--------------|-------------|----------------|----------------|------------------|
| Footstool      | 94cm        | 63cm        | 40cm         | –           | –              | –              | –                |
| Armchair       | 108cm       | 94cm        | 83cm         | 43cm        | 56cm           | 55cm           | –                |
| 2.5 Seat Sofa  | 173cm       | 94cm        | 83cm         | 43cm        | 120cm          | 55cm           | 2 x 40cm         |
| 3 Seat Sofa*   | 205cm       | 94cm        | 83cm         | 43cm        | 152cm          | 55cm           | 2 x 40cm         |
| 3.5 Seat Sofa* | 233cm       | 94cm        | 83cm         | 43cm        | 180cm          | 55cm           | 2 x 40cm         |
| 4 Seat Sofa*   | 263cm       | 94cm        | 83cm         | 43cm        | 210cm          | 55cm           | 2 x 40cm         |

\* Not shown

|                         |   |
|-------------------------|---|
| <b>Back Cushions</b>    | Duck feather back cushions                                      |
| <b>Seat Cushions</b>    | High quality foam seats with a deep fibre wrap                  |
| <b>Scatter Cushions</b> | Feather (fibre option available)                                |
| <b>Feet Finish</b>      | Beech finished in natural, light oak, ebony, mahogany and black |

If access is restricted, arms can be detached for delivery and refitted once in place. This service must be booked prior to delivery.

# Henley Modular

Henley modular is a well-proportioned and stylish sofa solution, allowing you to customise the size that's just right for your room.

See a few of our favourite configurations on the next page

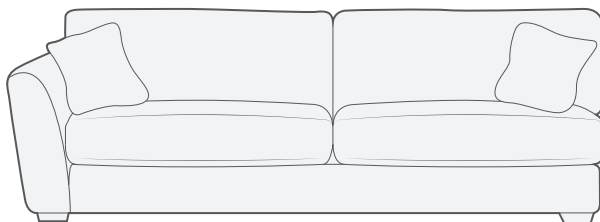

L/H or R/H Arm Sofa (various sizes – see below)

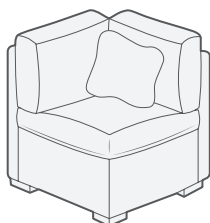

L/H or R/H Corner Unit

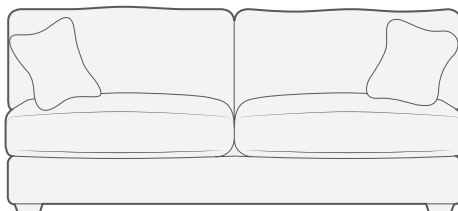

Armless Sofa (various sizes – see below)

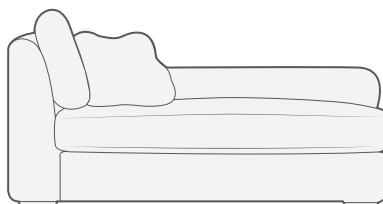
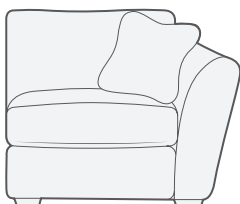

R/H or L/H Chaise (front and side view)

| Model                   | Total Width | Total Depth | Total Height | Seat Height | Internal Width | Internal Depth |
|-------------------------|-------------|-------------|--------------|-------------|----------------|----------------|
| 2.5 Seat Sofa (L/R arm) | 147cm       | 94cm        | 83cm         | 43cm        | 120cm          | 55cm           |
| 3 Seat Sofa (L/R arm)   | 179cm       | 94cm        | 83cm         | 43cm        | 152cm          | 55cm           |
| 3.5 Seat Sofa (L/R arm) | 207cm       | 94cm        | 83cm         | 43cm        | 180cm          | 55cm           |
| 4 Seat Sofa (L/R arm)   | 237cm       | 94cm        | 83cm         | 43cm        | 210cm          | 55cm           |
| 2.5 Seat Sofa (no arm)  | 121cm       | 94cm        | 83cm         | 43cm        | –              | 55cm           |
| 3 Seat Sofa (no arm)    | 153cm       | 94cm        | 83cm         | 43cm        | –              | 55cm           |
| 3.5 Seat Sofa (no arm)  | 181cm       | 94cm        | 83cm         | 43cm        | –              | 55cm           |
| 4 Seat Sofa (no arm)    | 181cm       | 94cm        | 83cm         | 43cm        | –              | 55cm           |
| Square Corner Unit      | 94cm        | 94cm        | 83cm         | 43cm        | –              | 55cm           |
| Chaise (L/R arm)        | 105cm       | 162cm       | 83cm         | 43cm        | –              | 120cm          |

# Henley Modular

Just a few popular configurations of this modular sofa – use the measurements on the previous page to create your unique sofa

---

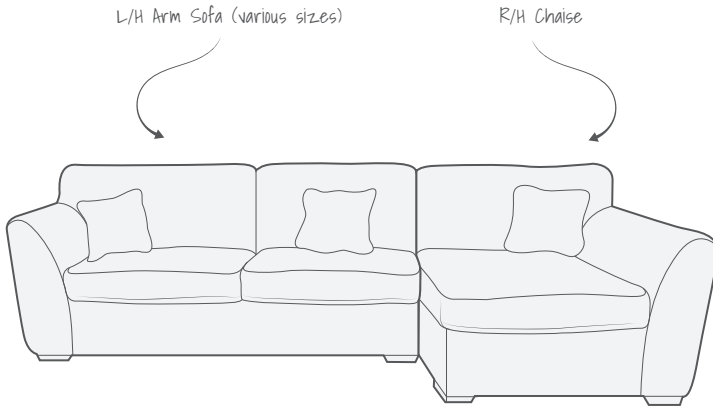

2 Piece combination as shown - L/H Arm Sofa (various sizes) + R/H Chaise

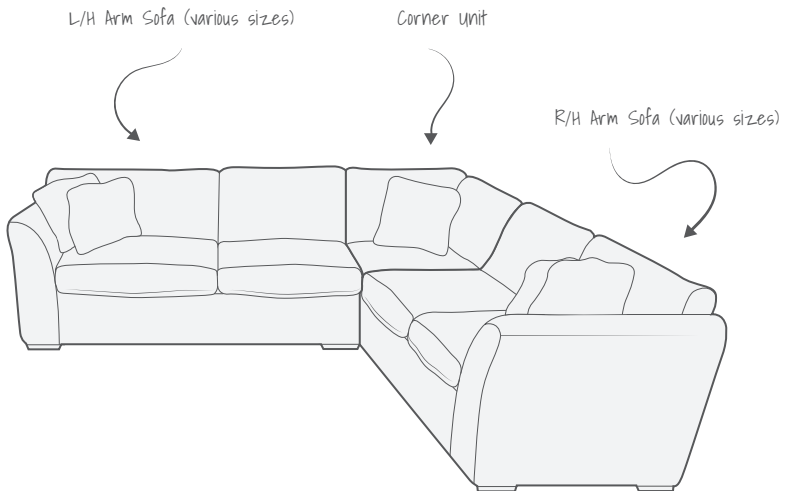

3 Piece combination as shown - L/H Arm Sofa (various sizes) + Corner unit + R/H Arm Sofa (various sizes)

## Top tips

- Always unclip the pieces before you try and move the sofa.
- Don't force the clips; they should fit together easily.
- Never drag the sofa - always lift it to protect your floor and the sofa brackets.
- Make sure the sofa is properly connected before you sit on it.
- Ensure the sofa is on an even surface.
- Avoid sitting on the arms.

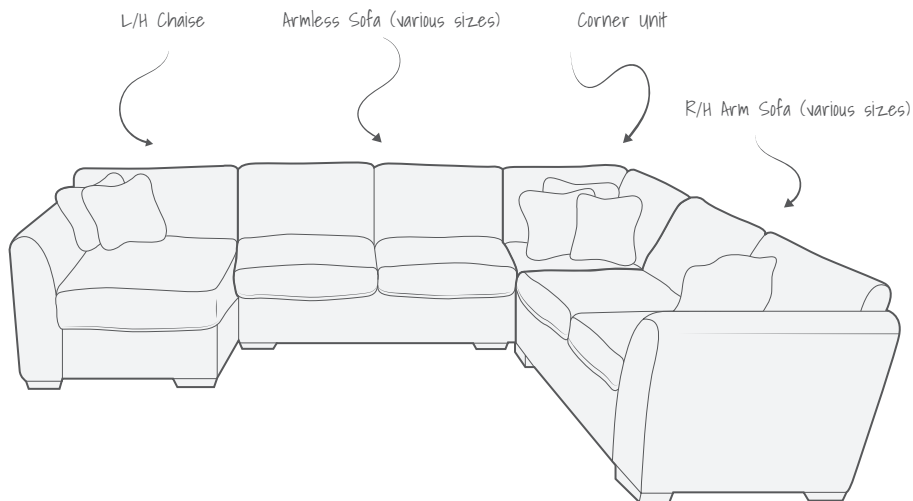

4 Piece combination as shown - L/H Chaise + Armless Sofa + Corner unit + R/H Arm Sofa (various sizes)

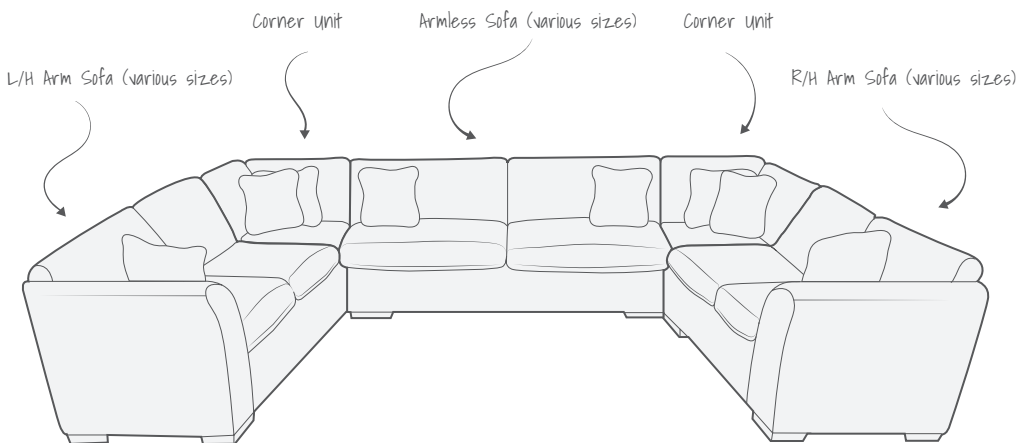

5 Piece combination as shown - L/H Arm Sofa (various sizes) + Corner unit + Armless Sofa + Corner unit + R/H Arm Sofa (various sizes)

# Accent Chairs

Our range of stand-alone chairs – perfect to use individually or alongside our sofas and modulares

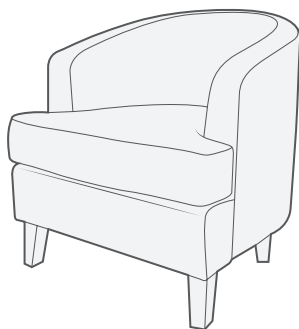

Moreton Tub Chair

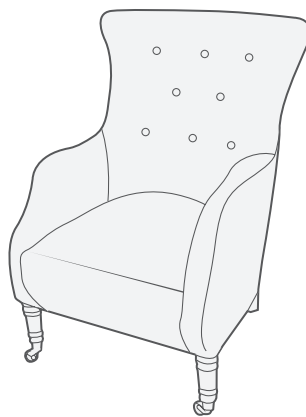

Marlborough Wing Chair

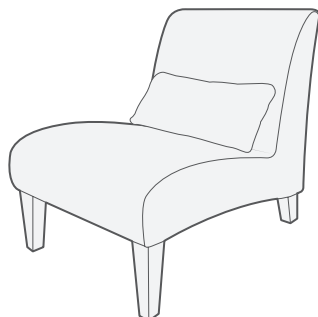

Stow Armless Chair

| Model       | Total Width | Total Depth | Total Height | Seat Height | Internal Width | Internal Depth |
|-------------|-------------|-------------|--------------|-------------|----------------|----------------|
| Moreton     | 73cm        | 78cm        | 77cm         | 46cm        | 47cm           | 64cm           |
| Marlborough | 73cm        | 85cm        | 104cm        | 42cm        | 56cm           | 54cm           |
| Stow        | 66cm        | 71cm        | 77cm         | 42cm        | 66cm           | 60cm           |

## Moreton

Fixed back and foam seat with a fibre wrap

Beech legs in natural, light oak, ebony, mahogany or black finish

If access is restricted feet can be detached for delivery and refitted once in place (this service must be booked prior to delivery)

## Marlborough

Fixed buttoned back and fixed seat

Oak legs in black or antique oak with antique brass or polished chrome castors

## Stow

Fixed back and seat with lumbar cushion

Beech legs in natural, light oak, ebony, mahogany or black finish

Due to frame construction, Stow and Marlborough chairs are delivered with legs fitted



# Footstools

Our collection of ottomans and footstools are practical as well as effortlessly stylish

---

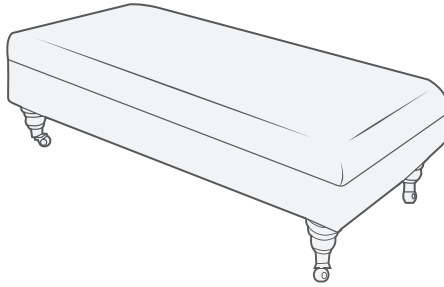

Stamford Plain Top Footstool

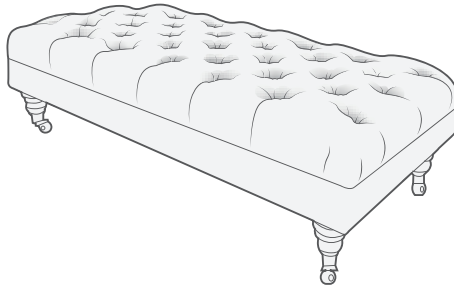

Burford Deep Buttoned Top Footstool

| Model              | Total Width | Total Depth | Total Height |
|--------------------|-------------|-------------|--------------|
| Small Square       | 60cm        | 60cm        | 40cm         |
| Medium Rectangle   | 90cm        | 60cm        | 40cm         |
| Large Square       | 90cm        | 90cm        | 40cm         |
| X-Large Rectangle  | 120cm       | 60cm        | 40cm         |
| XX-Large Rectangle | 180cm       | 90cm        | 40cm         |

**Feet Finish** Oak finished in black or antique oak with brass, brushed nickel, polished or black chrome castors

# Furniture Delivery Guide

*Our guide to a smooth delivery experience!*

Your sofas and chairs will be expertly delivered by our specialist delivery partner team but, to help make it a stress free experience, a little checking on the measurements beforehand will avoid any surprises on delivery day. To assist you with this, we have created this handy guide to help you work out if your furniture will fit into your room via doors, hallways and stairs.

Modular sofas are always delivered in sections for assembly in your room. Most of our sofas and armchairs have removable legs and some models can be delivered with arms removed, then reconstructed in your room at an additional charge.

## Access Check Points

Firstly, note down the length, depth and height of your furniture. This information can be found on the product pages of this leaflet. Next, let's look at the access points:

### Front Door

Compare the width of your door frame (A) with the height of your sofa (B) allowing a little wiggle room on either side. This will determine if we can take the item through on its side. If the door width is greater than the height of your item, then it will fit through on its side.

If the width of your front door is too narrow, then our delivery team can try to bring your item through upright. In this case, measure the height of your doorway (H) making sure that it is greater than your item's length (L). Again, check that there is some wiggle room. Don't forget, we are able to remove the legs on most sofas and armchairs.

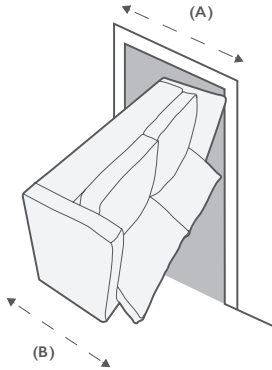

Side Access

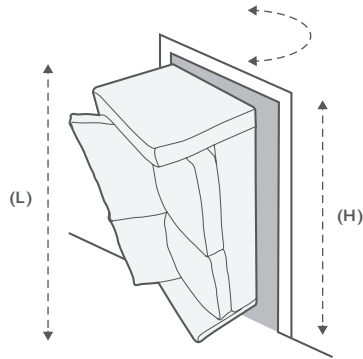

Upright Access

### Top Tip

Clearing the route to the room, including outside space, as much as possible before the delivery drivers arrive is the best way to help ensure a smooth delivery. This gives a little more space to manoeuvre and help to protect your home, valuables and existing furniture from any damage during installation.

## Hallways

We need to make sure your furniture can get into the room that you'd like it to sit in. Measure the width of any areas that the item must pass through, such as hallways and internal doors at their narrowest points. Remember to take note of possible obstructions such as radiators, shelving, skirting boards and light fittings. As long as the width at the narrowest point is greater than the height of your item, then your furniture will fit.

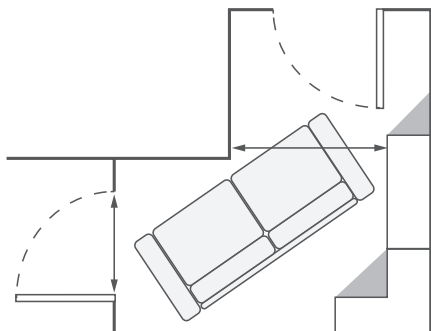

## Stairs

If your furniture needs to go up any stairs, measure the width of the staircase at its narrowest point. Remember to take any handrails or light fixtures into account. If this distance is wider than the height of your item, it should fit. If there is a half landing, measure its width (W), depth (D), and height (H).

If you have a bannister and the furniture needs to be lifted over it, check that the distance between the bannister and the ceiling is greater than the depth of the item. Once at the top of the stairs, make sure there is enough room on the landing for our delivery team to manoeuvre your item into your chosen room.

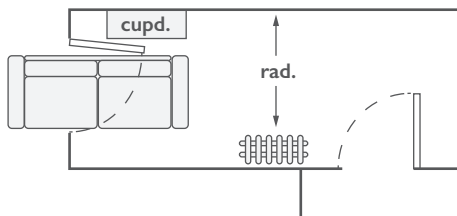
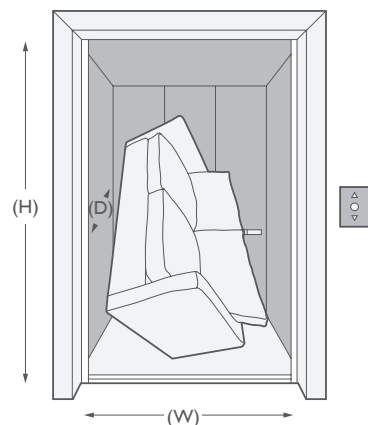

## Tight Corners

You might need to note the clearance (distance from the door to the next prominent obstacle, e.g. wall, bannister) if the sofa is to enter a particularly tight corner.

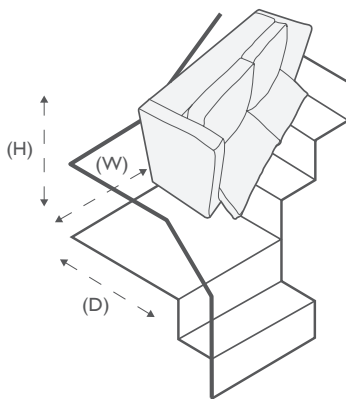

## Lifts

We can deliver to second floors and above if your building has a lift. Measure the open door height (H), width (W) and depth (D - front to back of the lift) to make sure we can fit your sofa inside.

## And Finally...

Once in position, please take a good look at your furniture all round, back, front and sides, to make sure you are completely happy with everything before our delivery team leaves you to sit back and enjoy your new upholstery.

## Index

|                    |       |
|--------------------|-------|
| Blenheim           | 11    |
| Burford            | 21    |
| Campden            | 6     |
| Delivery Guide     | 22    |
| Henley             | 16    |
| Henley Modular     | 17–19 |
| Marlborough        | 20    |
| Marlow             | 7     |
| Moreton            | 20    |
| Padstow            | 4     |
| Prestbury          | 8–9   |
| Salcombe           | 5     |
| Stamford           | 21    |
| Stow               | 20    |
| Tunbridge          | 12    |
| Tunbridge Modular  | 14–15 |
| Tunbridge Sofa Bed | 13    |
| Woodstock          | 10    |

PROUD TO PARTNER WITH

ANDREW MARTIN



MULBERRY  
HOME

ARTE®

Nina Campbell

Baker Lifestyle

OSBORNE & LITTLE



Christian Lacroix

PIERRE FREY  
PARIS

Cole & Son®



DESIGNERS GUILD

RALPH LAUREN

GP & J BAKER



SketchTwenty3



JAMES HARE  
SINCE 1865

WARWICK

MATTHEW WILLIAMSON  
at  
OSBORNE & LITTLE

WILLIAM YEOWARD

# the home library

LIGHTING & INTERIORS



[www.thehomelibrary.com](http://www.thehomelibrary.com)

